

User Manual

Optical Headend

Ref. 4002 & 4003 & 4004

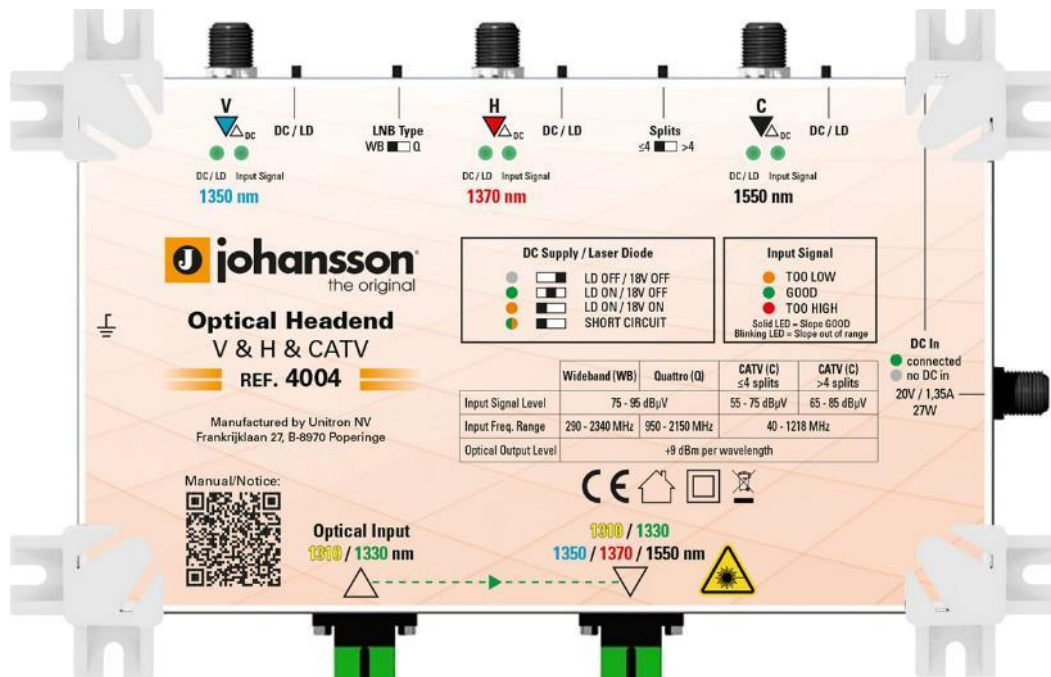

CONTENTS

1. INTRODUCTION	3
Product description	3
Package contents	3
2. CONFIGURATION OF THE MODULE.....	4
3. INSTALLATION OF THE HARDWARE	6
Wideband to SCR (up to 64 splits)	6
Hybrid dSCR Solution: Wideband to SCR + CATV (up to 64 splits)	7
Legacy and dSCR: Wideband to SCR + CATV (up to 64 splits)	8
Dual Wideband + CATV (up to 32 splits).....	9
4. TECHNICAL SPECIFICATIONS	10
5. SAFETY INSTRUCTIONS	11
6. CONDITIONS OF WARRANTY	12

No part of this manual may be copied, reproduced, transmitted, transcribed or translated into any language without permission.

Unitron reserves the right to change the specifications of the hardware and software described in these manuals at any time.

Unitron cannot be held liable for any damages resulting from the use of this product. Specifications are subject to change without notice. 2/23

© Unitron NV - Frankrijklaan 27 - B-8970 Poperinge - Belgium

T +32 57 33 33 63 F +32 57 33 45 24

sales@unitrongroup.com

www.unitrongroup.com

1. INTRODUCTION

Product description

The new Optical Compact Headend converts Wideband/CATV signals to multiple optical wavelengths. Thanks to built-in Automatic Gain Control (AGC) and Automatic Slope Control (ASC), the output signal quality is optimal for your optical distribution system (9 dBm output power). The Optical Transmitters are suited for many types of optical systems: up to 64 splits, up to 128 splits and even more than 2000 splits!

REF 4002: OPTICAL HEADEND TRANSMITTER 2 WAVELENGTHS

- 2 Wideband inputs
- Frequency range: SAT: 290 – 2340 MHz (Wideband) / 950 – 2150 MHz (Quattro)
- 1 Optical output (wavelengths 1310 - 1330nm)

REF 4003: OPTICAL HEADEND TRANSMITTER 3 WAVELENGTHS

- 2 Wideband and 1 CATV inputs
- frequency range: SAT: 290 – 2340 MHz (Wideband) / 950 – 2150 MHz (Quattro) /
CATV: 40 – 1218 MHz
- 1 Optical output (wavelengths 1310 – 1330 - 1550nm)

REF 4004: OPTICAL HEADEND TRANSMITTER 3 WAVELENGTHS

- 2 Wideband and 1 CATV inputs
- frequency range: SAT: 290 – 2340 MHz (Wideband) / 950 – 2150 MHz (Quattro) /
CATV: 40 – 1218 MHz
- 1 Optical output (wavelengths 1350 – 1370 -1550 & 1310 – 1330 from **optical loopthrough**)

Package contents

- 1x Optical Headend (REF 4002 or REF 4003 or REF 4004)
- **Not included**: 20V / 3A Power Supply (Ref. 2460)

2. CONFIGURATION OF THE MODULE

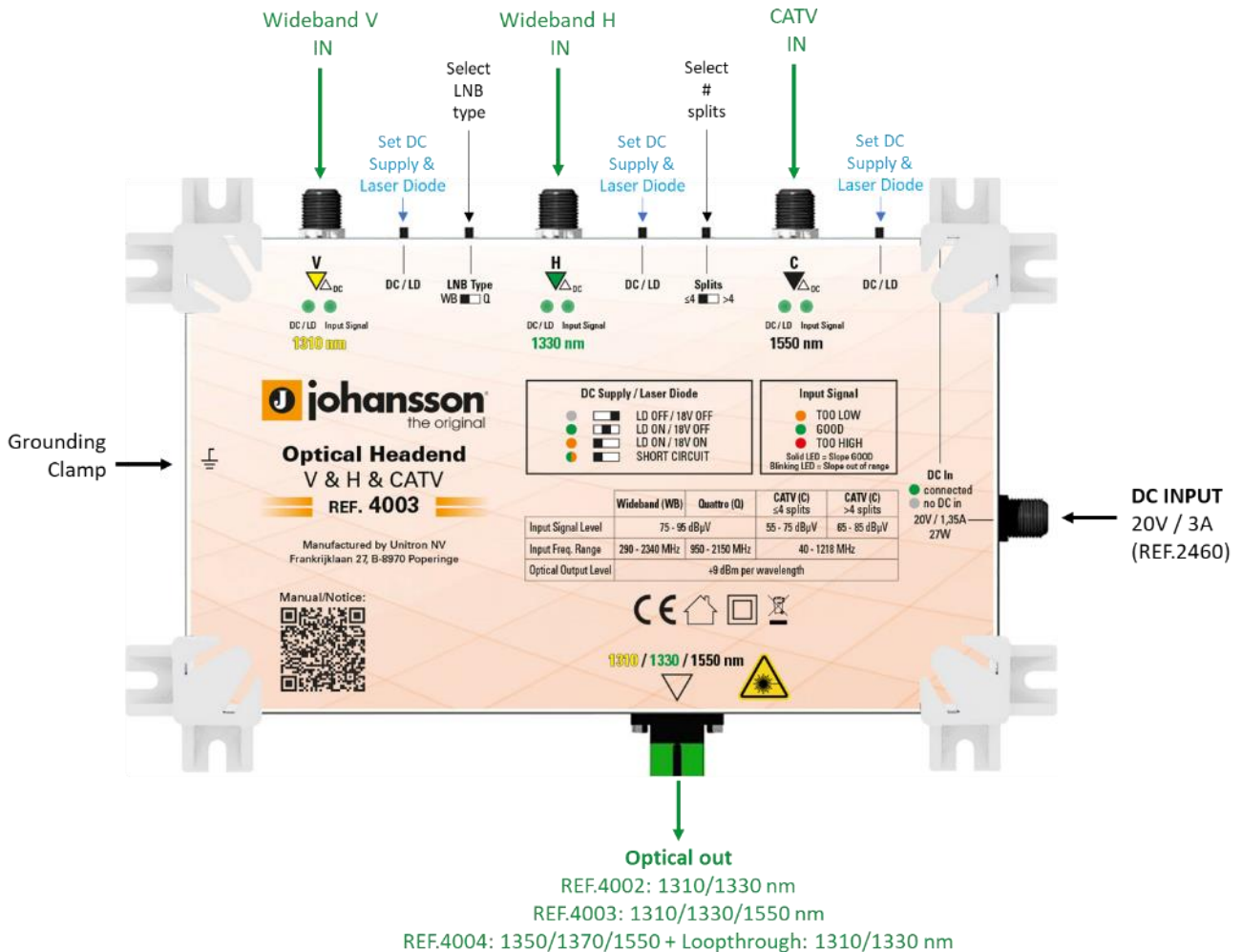

Select LNB Type:

With this switch you can select the frequency range of the Sat input signal. This is necessary to make the Automatic Slope Control (ASC) working properly. If signals of a Quattro LNB are inserted, then set the switch to "Q". If Wideband signals are inserted, set the switch to "WB".

Select # splits (only for REF. 4003 and REF. 4004):

With this switch you can select the number of splits in your system, this is necessary to make the Automatic Gain Control working properly.

Signal Quality LED:

The signal quality LED shows you the quality of the signal with different colors.

Orange Color: Signal level is too low. In this case you should amplify the signal with an external amplifier.

Green Color: Signal level is within the AGC supported range.

Red Color: Signal level is too high. You need to attenuate the signal with external attenuator(s).

Solid LED: Slope is OK

Blinking LED: Slope is out of range

Set DC Supply and Laser Diode:

With this switch you can set the DC (18V) supply to the RF input and switch off the Laser Diode (LD) in order to measure each optical signal separately. To measure the signal strength of a certain wavelength, you need to switch off both other Laser Diodes. Don't forget to switch all LDs on after measurement.

The LED is **off** if no DC is supplied to the RF input and if no DC is supplied to the Laser Diode. If no DC is supplied to the laser diode, the related signal is not converted into an optical signal. Please make sure to switch on at least the laser diode for proper operation.

The LED is **green** if the Laser diode is switched on and the related output voltage off.

The LED is **orange** if the Laser diode is switched on the related output voltage is supplied to the RF input.

The LED is **green/orange** blinking if DC is supplied to the RF input and the device recognized a short circuit.

Optical output:

The optical transmitters each have an optical output power of +9 dBm per wavelength. For REF.4003 and REF. 4004, make sure to set the select the right number of splits using the split switch.

3. INSTALLATION OF THE HARDWARE

Wideband to SCR (up to 64 splits)

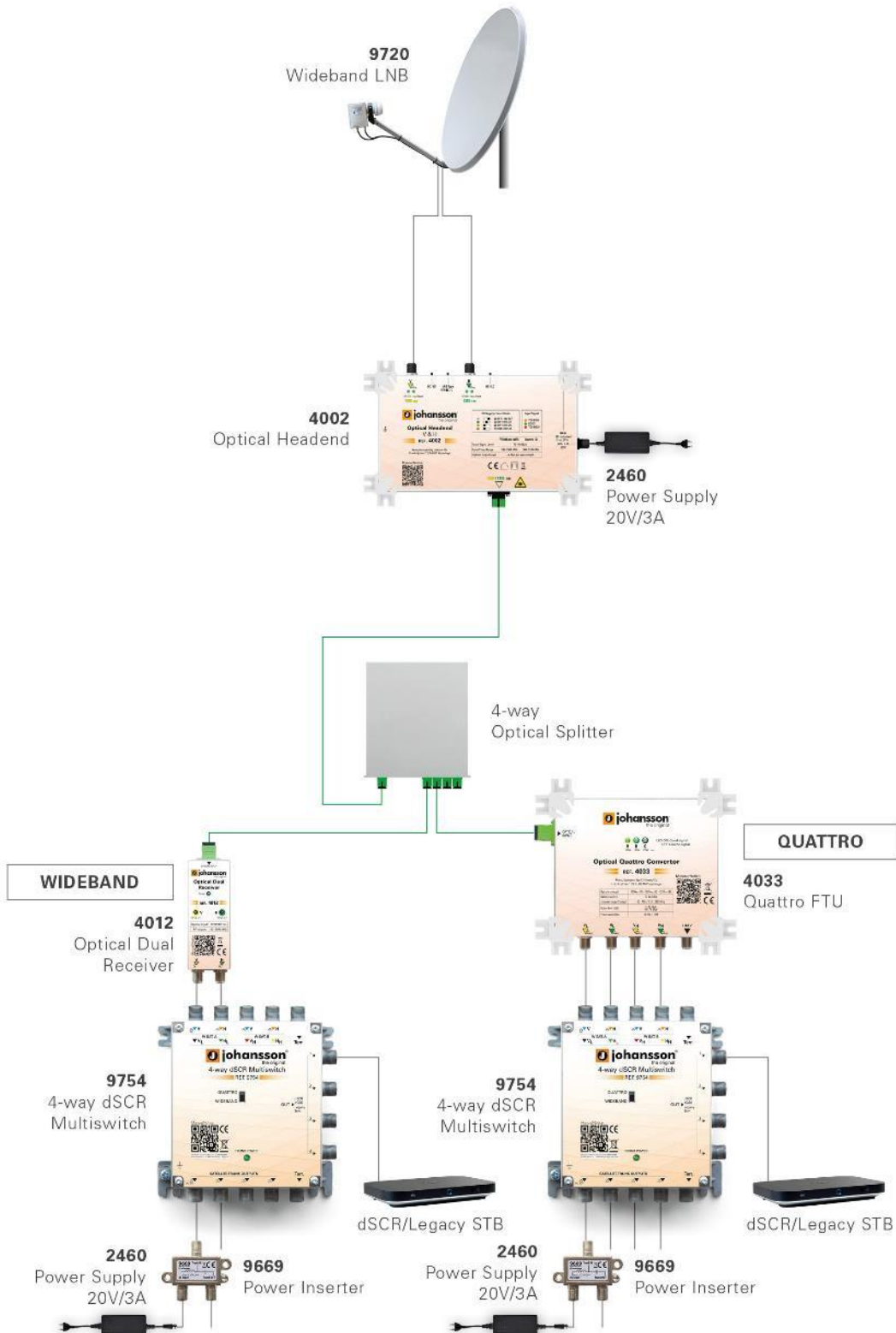

Hybrid dSCR Solution: Wideband to SCR + CATV (up to 64 splits)

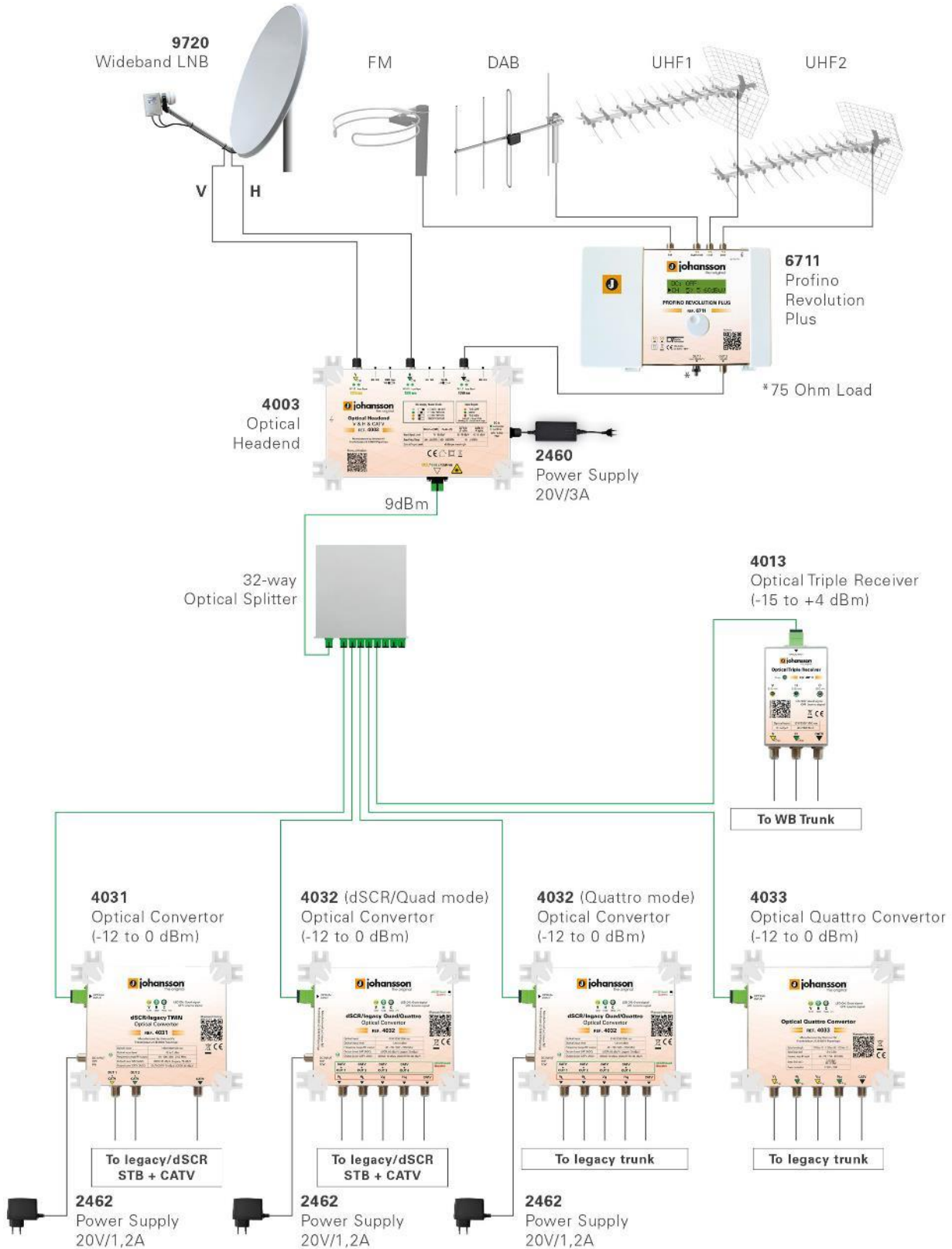

Legacy and dSCR: Wideband to SCR + CATV (up to 64 splits)

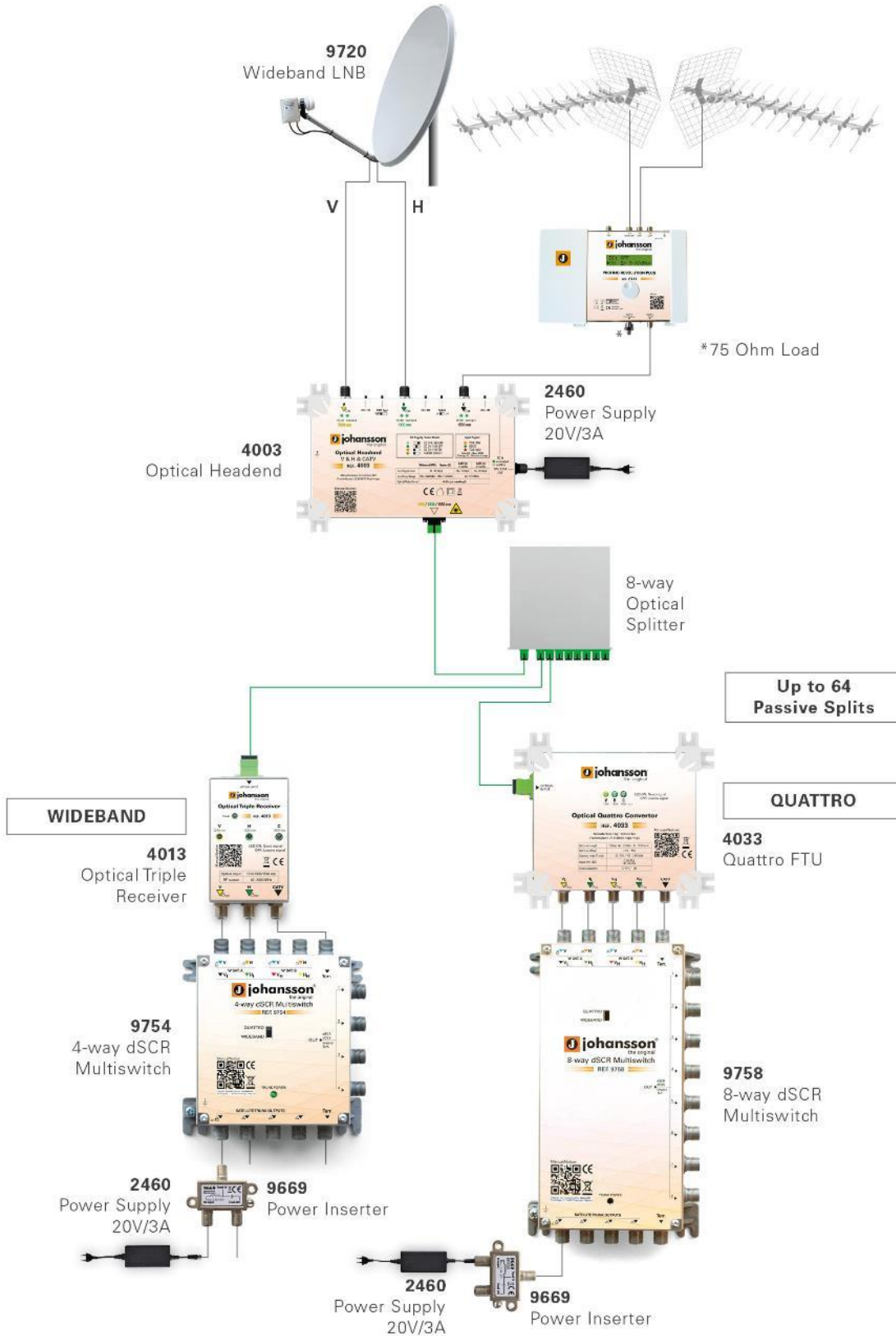

Dual Wideband + CATV (up to 32 splits)

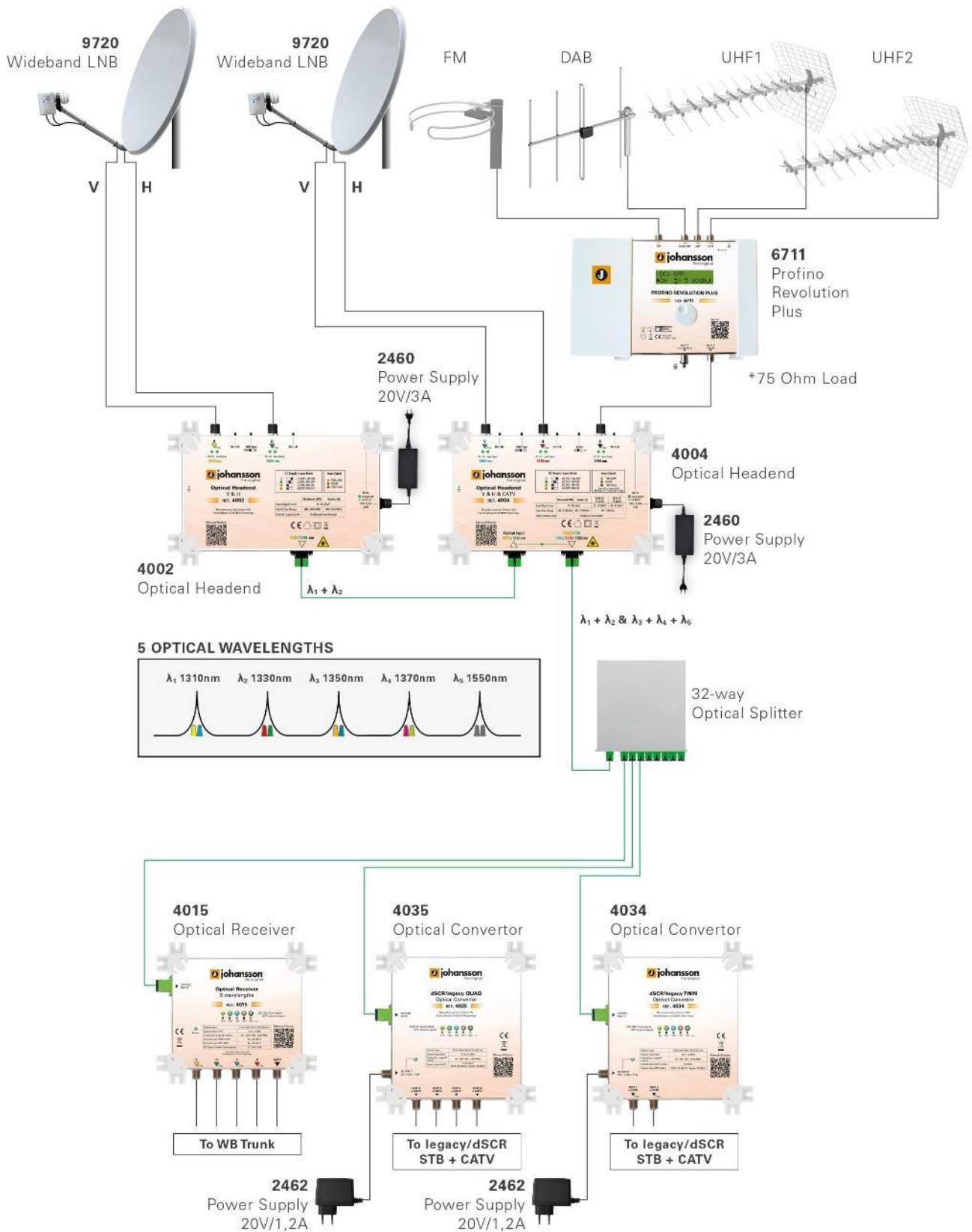

4. TECHNICAL SPECIFICATIONS

		REF 4002	REF 4003	REF 4004
RF Inputs (F-connector)	-	2 x Satellite (WB / Q)	2 x Satellite (WB / Q) 1 x CATV	
Input frequency SAT	MHz	Wideband: 290 - 2340 Quattro: 950 - 2150		
Input frequency CATV	MHz	-	47 - 1218	
Optical outputs (SC/APC)	-	1		
Optical inputs (SC/APC)		-	-	1
Optical output wavelengths	nm	1310 - 1330	1310 – 1330 - 1550	1310 – 1330 (Bypass) 1350 – 1370 – 1550
Optical output power	dBm	+9 (per wavelength)		
Minimal input level SAT	dB μ V	75 - 95		
Minimal input level CATV	dB μ V	-	55 - 75 (CATV \leq 4 splits) 65 - 85 (CATV >4 splits)	
DC supply	-	18V / 400mA		
DC supply CATV	-	-	12V / 200mA	
Automatic Gain Control	dB	15		
Automatic Slope Control	dB	10		
Power consumption	W	22	27	
DC input	-	20 V / 1.1A (F-type)	20 V / 1.35A (F-type)	
Power Supply	-	Use a 20V / 3A Power Supply (Ref. 2460) Not included with product		
Operating temperature range	$^{\circ}$ C	-10 to +50		
Dimensions	Mm	221 x 141 x 50		
Weight	kg	0.8		

5. SAFETY INSTRUCTIONS



Read these instructions carefully before connecting the unit



-  To prevent fire, short circuit or shock hazard:
 - Do not expose the unit to rain or moisture.
 - Install the unit in a dry location without infiltration or condensation of water.
 - Do not expose it to dripping or splashing.
 - Do not place objects filled with liquids, such as vases, on the apparatus.
 - If any liquid should accidentally fall into the cabinet, disconnect the power plug.

-  To avoid any risk of overheating:
 - Install the unit in a well aery location and keep a minimum distance of 15 cm around the apparatus for sufficient ventilation
 - Do not place any items such as newspapers, table-cloths, curtains, on the unit that might cover the ventilation holes.
 - Do not place any naked flame sources, such as lighted candles, on the apparatus
 - Do not install the product in a dusty place
 - Use the apparatus only in moderate climates (not in tropical climates)
 - Respect the minimum and maximum temperature specifications

-  To avoid any risk of electrical shocks:
 - Connect apparatus only to socket with protective earth connection.
 - The mains plug shall remain readily operable
 - Pull out power plug to make the different connections of cables
 - To avoid electrical shock, do not open the housing of adapter.



Maintenance

-  Only use a dry soft cloth to clean the cabinet.
-  Do not use solvent
-  For repairing and servicing refer to qualified personnel.



Dispose according your local authority's recycling processes

6. CONDITIONS OF WARRANTY

Unitron N.V. warrants the product as being free from defects in material and workmanship for a period of 24 months starting from the date of production indicated on it. See note below.

If during this period of warranty the product proves defective, under normal use, due to defective materials or workmanship, Unitron N.V, at its sole option, will repair or replace the product. Return the product to your local dealer for reparation.

THE WARRANTY IS APPLIED ONLY FOR DEFECTS IN MATERIAL AND WORKMANSHIP AND DOES NOT COVER DAMAGE RESULTING FROM:

- Misuse or use of the product out of its specifications,
- Installation or use in a manner inconsistent with the technical or safety standards in force in the country where the product is used,
- Use of non-suitable accessories (power supply, adapters...),
- Installation in a defect system,
- External cause beyond the control of Unitron N.V. such as drop, accidents, lightning, water, fire, improper ventilation...

THE WARRANTY IS NOT APPLIED IF

- Production date or serial number on the product is illegible, altered, deleted or removed.
- The product has been opened or repaired by a non-authorized person.

NOTE

Date of production can be found in the product's serial number code. The format will either be "YEAR W WEEK" (e.g., 2017W32 = year 2017 week 32) or "YYWW" (e.g., 1732 = year 2017 week 32).



www.unitrongroup.com

UNITRON NV
Frankrijklaan 27
B-8970 Poperinge
Belgium

T +32 57 33 33 63

sales@unitrongroup.com

www.unitrongroup.com